

## M2p.65xx-x4 - 16 bit 125 MS/s Arbitrary Waveform Generator

- Up to 125 MS/s on four channels
- Up to 80 MS/s on eight channels
- One, two, four and eight channel versions
- Versions with 40 MS/s and 125 MS/s
- Ultra Fast PCI Express x4 interface
- Simultaneous signal generation on all channels
- Output level max.  $\pm 3$  V into 50 Ohm ( $\pm 6$  V into 1 MOhm)
- Features: Single-Shot, Loop, FIFO, Gated Replay, Sequence Replay
- 512 MSamples on-board memory
- Synchronization of up to 16 cards per system
- Fixed trigger to output delay
- Direct data transfer from CUDA GPU using SCAPP option



**M2p**  
series

- PCIe x4 Gen 1 Interface
- Works with x4/x8/x16\* PCIe slots
- Sustained streaming mode up to 700 MB/s\*\*
- Half-length PCIe Form Factor

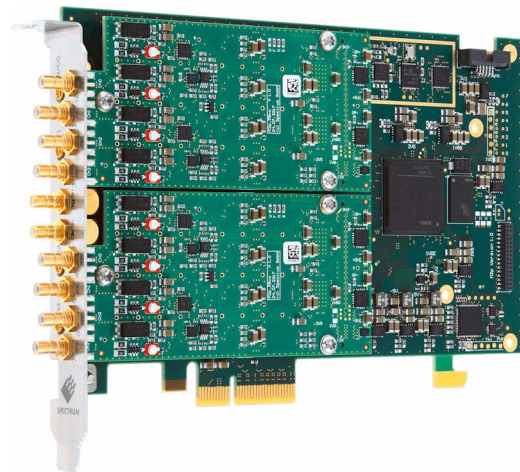

<b>Operating Systems</b>	<b>Recommended Software</b>	<b>Drivers</b>
<ul style="list-style-type: none"> <li>• Windows 7 (SP1), 8, 10, Server 2008 R2 and newer</li> <li>• Linux Kernel 2.6, 3.x, 4.x, 5.x</li> <li>• Windows/Linux 32 and 64 bit</li> </ul>	<ul style="list-style-type: none"> <li>• Visual C++, Delphi, C++ Builder, GNU C++, VB.NET, C#, J#, Java, Python</li> <li>• SBench 6</li> </ul>	<ul style="list-style-type: none"> <li>• MATLAB</li> <li>• LabVIEW</li> <li>• LabWindows/CVI</li> <li>• IVI</li> </ul>

Model	Analog output channels				Output Level	
	1 ch	2 ch	4 ch	8 ch	in 50 $\Omega$	in 1 M $\Omega$
M2p.6530-x4	40 MS/s				$\pm 3$ V	$\pm 6$ V
M2p.6531-x4	40 MS/s	40 MS/s			$\pm 3$ V	$\pm 6$ V
M2p.6536-x4	40 MS/s	40 MS/s	40 MS/s		$\pm 3$ V	$\pm 6$ V
M2p.6533-x4	40 MS/s	40 MS/s	40 MS/s	40 MS/s	$\pm 3$ V	$\pm 6$ V
M2p.6560-x4	125 MS/s				$\pm 3$ V	$\pm 6$ V
M2p.6561-x4	125 MS/s	125 MS/s			$\pm 3$ V	$\pm 6$ V
M2p.6566-x4	125 MS/s	125 MS/s	125 MS/s		$\pm 3$ V	$\pm 6$ V
M2p.6568-x4	125 MS/s	125 MS/s	125 MS/s	80 MS/s	$\pm 3$ V	$\pm 6$ V

### General Information

The M2p.65xx series offers different versions of arbitrary waveform generators for PCI Express with a maximum output rate of 125 MS/s. These boards allow to generate freely definable waveforms on several channels synchronously.

With one of the synchronization options the setup of synchronous multi channel systems is possible as well as the combination of arbitrary waveform generators with digitizers of the M2p product family.

The 512 MSample on-board memory can be used as arbitrary waveform storage or as a FIFO buffer continuously streaming data via the PCIe interface.

The high-resolution 16-bit DACs deliver four times the resolution of AWGs using 14-bit technology.

\*Some x16 PCIe slots are for the use of graphic cards only and can't be used for other cards. \*\*Throughput measured with a motherboard chipset supporting a TLP size of 256 bytes.

## Software Support

### Windows drivers

The cards are delivered with drivers for Windows 7, Windows 8 and Windows 10 (each 32 bit and 64 bit). Programming examples for Visual C++, C++ Builder, LabWindows/CVI, Delphi, Visual Basic, VB.NET, C#, J#, Python, Java and IVI are included.

### Linux Drivers



All cards are delivered with full Linux support. Pre compiled kernel modules are included for the most common distributions like Fedora, Suse, Ubuntu LTS or Debian. The Linux support includes SMP systems, 32 bit and 64 bit systems, versatile programming examples for GNU C++, Python as well as the possibility to get the driver sources for your own compilation.

### SBench 6

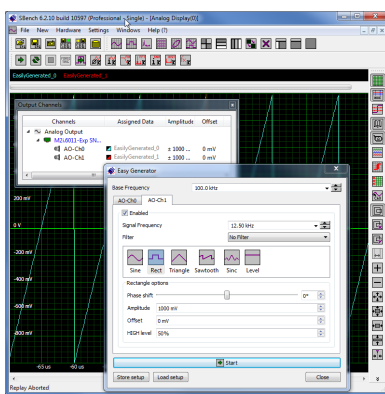

A base license of SBench 6, the easy-to-use graphical operating software for Spectrum cards, is included in the delivery. The base license makes it possible to test the card, generate simple signals or load and replay previously stored SBench 6 signals. It's a valuable tool for checking the cards performance and assisting

with the units initial setup. The cards also come with a demo license for the SBench6 professional version. This license gives the user the opportunity to test the additional features of the professional version with their hardware. The professional version contains several advanced measurement functions, such as FFTs and X/Y display, import and export utilities as well as support for all replay modes including data streaming. Data streaming allows the cards to continuously replay data and transfer it directly from the PC RAM or hard disk. SBench 6 has been optimized to handle data files of several GBytes. SBench 6 runs under Windows as well as Linux (KDE and GNOME) operating systems. A test version of SBench 6 can be downloaded directly over the internet and can run the professional version in a simulation mode without any hardware installed. Existing customers can also request a demo license for the professional version from Spectrum. More details on SBench 6 can be found in the SBench 6 data sheet.

### SCAPP – CUDA GPU based data processing

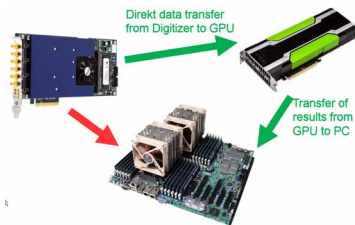

For applications requiring high powered signal and data processing Spectrum offers SCAPP (Spectrum's CUDA Access for Parallel Processing). The SCAPP SDK allows a direct link between Spectrum digitizers, AWGs or Digital Data Acquisition Cards

and CUDA based GPU cards. Once in the GPU users can harness the processing power of the GPU's multiple (up to 5000) processing cores and large (up to 24 GB) memories. SCAPP uses an RDMA (Linux only) process to send data at the full PCIe transfer speed to and from the GPU card. The SDK includes a set of examples for interaction between the Spectrum card and the GPU card and another set of CUDA parallel processing examples with easy building blocks for basic functions like filtering, averaging, data de-multi-

plexing, data conversion or FFT. All the software is based on C/C++ and can easily be implemented, expanded and modified with normal programming skills.

### Third-party products

Spectrum supports the most popular third-party software products such as LabVIEW, MATLAB or LabWindows/CVI. All drivers come with detailed documentation and working examples are included in the delivery. Support for other software packages, like VEE or DaqLab, can also be provided on request.

### Hardware features and options

#### PCI Express x4



The M2p series cards use a PCI Express x4 Gen 1 connection. They can be used in PCI Express x4, x8 and x16 slots with hosts supporting Gen 1, Gen 2 or Gen 3.

The maximum sustained data transfer rate is more than 700 MByte/s (read direction) or 700 MByte/s (write direction) per slot. Physically supported slots that are electrically connected with only x1 or x2 can also be used with the M2p series cards, but with reduced data transfer rates.

### Connections

The cards are equipped with SMB connectors for the analog signals as well as for the external trigger and clock input. In addition, there are four MMCX connectors: one multi-function output (X0) and three multi-function I/O connectors (X1, X2, X3). These multi-function connectors can be individually programmed to perform different functions:

- Clock output (X0 only)
- Trigger output
- Status output (armed, triggered, ready, ...)
- Synchronous digital inputs, being stored inside the analog data samples
- Asynchronous I/O lines
- Logic trigger inputs



### Singleshot output

When singleshot output is activated the data of the on-board memory is played exactly one time. The trigger source can be either one of the external trigger inputs or the software trigger. After the first trigger additional trigger events will be ignored.

### Repeated output

When the repeated output mode is used the data of the on-board memory is played continuously for a programmed number of times or until a stop command is executed. The trigger source can be either one of the external trigger inputs or the software trigger. After the first trigger additional trigger events will be ignored.

### Single Restart replay

When this mode is activated the data of the on-board memory will be replayed once after each trigger event. The trigger source can be either the external TTL trigger or software trigger.

### FIFO mode

The FIFO or streaming mode is designed for continuous data transfer between the card and the PC memory. When mounted in a PCI Express x4 Gen 1 interface read streaming speeds of up to 700 MByte/s are possible. The control of the data stream is done automatically by the driver on interrupt request basis. The complete installed onboard memory is used to buffer the data, making the continuous streaming process extremely reliable.

### Multiple Replay

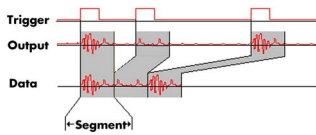

The Multiple Replay mode allows the fast output generation on several trigger events without restarting the hardware. With this option very fast repetition rates can be achieved.

The on-board memory is divided into several segments of the same size. Each segment can contain different data which will then be played with the occurrence of each trigger event.

### Gated Replay

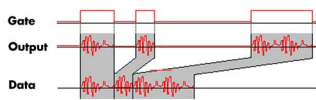

The Gated Sampling mode allows data replay controlled by an external gate signal. Data is only replayed if the gate signal has attained a

programmed level.

### Sequence Mode

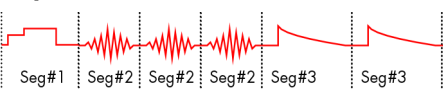

The sequence mode allows to split the card memory into several

data segments of different length. These data segments are chained up in a user chosen order using an additional sequence memory. In this sequence memory the number of loops for each segment can be programmed and trigger conditions can be defined to proceed from segment to segment. Using the sequence mode it is also possible to switch between replay waveforms by a simple software command or to redefine waveform data for segments simultaneously while other segments are being replayed. All trigger-related and software-command-related functions are only working on single cards, not on star-hub-synchronized cards.

### External trigger input

All boards can be triggered using an external analog or digital signal. The external trigger input has one comparator that can be used for standard edge and level triggers.

### External clock input and output

Using a dedicated connector a sampling clock can be fed in from an external system. Additionally it's also possible to output the internally used sampling clock on a separate connector to synchronize external equipment to this clock.

### Reference clock

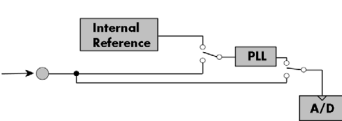

The option to use a precise external reference clock (typically 10 MHz) is necessary to synchronize the instrument for high-quality measurements with external equipment (like a signal source). It's also possible to enhance the stability of the sampling clock in this way. The driver automatically generates the requested sampling clock from the fed in reference clock.

-

### Star-Hub



The Star-Hub is an additional module allowing the phase stable synchronization of up to 16 boards in one system. Two versions are available: one with up to 6 cards and the large version supports up to 16 cards in one system. Both versions can be mounted in two different ways, to either extend the cards

length to  $\frac{3}{4}$  PCIe length occupying one slot, or extend its width to two slots whilst keeping the  $\frac{1}{2}$  PCIe length.



Independent of the number of boards there is no phase delay between the channels. The Star-Hub distributes trigger and clock information between all boards. As a result all connected boards are running with the same clock and the same trigger. All trigger sources can be combined with OR/AND. For digitizers that means all channels of all cards to be trigger source at the same time.

## Technical Data

### Analog Outputs

Resolution		16 bit
D/A Interpolation		no interpolation
Output amplitude	software programmable	$\pm 1$ mV up to $\pm 3$ V in 1 mV steps into 50 $\Omega$ termination (resulting in $\pm 2$ mV up to $\pm 6$ V in 2 mV steps into high impedance loads)
Output Amplifier Path Selection	automatically by driver	Note: Gain values below $\pm 300$ mV into 50 $\Omega$ are reduced by digital scaling of the samples Low Power path: Selected Gain of $\pm 1$ mV to $\pm 960$ mV (into 50 $\Omega$ ) High Power path: Selected Gain of $\pm 940$ mV to $\pm 3$ V (into 50 $\Omega$ )
Output Amplifier Setting Hysteresis	automatically by driver	940 mV to 960 mV (if output is using low power path it will switch to high power path at 960 mV. If output is using high power path it will switch to low power path at 940 mV)
Output amplifier path switching time		TBD ms (output disabled while switching)
Output offset	software programmable	Low Power path: $\pm 960$ mV in 1 mV steps into 50 $\Omega$ ( $\pm 1920$ mV in 2 mV steps into high-Z) High Power path: $\pm 3$ V in 1 mV steps into 50 $\Omega$ ( $\pm 6$ V in 2 mV steps into high-Z)
Filters	software programmable	One of 4 different filters (refer to „Bandwidth and Filters“ section)
DAC Differential non linearity (DNL)	DAC only	$\pm 2.0$ LSB typical
DAC Integral non linearity (INL)	DAC only	$\pm 4.0$ LSB typical
Output resistance		50 $\Omega$
Minimum output load		0 $\Omega$ (short circuit save)
Max output swing in 50 $\Omega$		$\pm 3.0$ V (offset + amplitude)
Max output swing in 1 M $\Omega$		$\pm 6.0$ V (offset + amplitude)
Slewrate (using Filter 0)		TBD V/ns
Crosstalk @ 1 MHz signal $\pm 3$ V	1 to 4 channel AWG	95 dB
Crosstalk @ 1 MHz signal $\pm 3$ V	8 channel AWG	TBD
Output accuracy		Low Power path: $\pm$ TBD mV $\pm$ TBD % of programmed output amplitude High Power path: $\pm$ TBD mV $\pm$ TBD % of programmed output amplitude

### Trigger

Available trigger modes	software programmable	External, Software, Pulse, Re-Arm, Or/And, Delay
Trigger edge	software programmable	Rising edge, falling edge or both edges
Trigger pulse width	software programmable	0 to [4G - 1] samples in steps of 1 sample
Trigger delay	software programmable	0 to [4G - 1] samples in steps of 1 samples
Trigger holdoff (for Multi, Gate)	software programmable	0 to [4G - 1] samples in steps of 1 samples
Multi, Gate: re-arming time		< 24 samples (+ programmed holdoff)
Trigger to Output Delay		63 sample clocks + 7 ns
Memory depth	software programmable	16 up to [installed memory / number of active channels] samples in steps of 8
Multiple Replay segment size	software programmable	8 up to [installed memory / number of active channels] samples in steps of 8
External trigger accuracy		1 sample
External trigger		<b>Ext</b>
External trigger type		Single level comparator
External trigger impedance	software programmable	50 $\Omega$ / 5 k $\Omega$
External trigger input level		$\pm 5$ V (5 k $\Omega$ ), $\pm 2.5$ V (50 $\Omega$ ), $\pm 20$ V (5 k $\Omega$ ), 5 Vrms (50 $\Omega$ )
External trigger over voltage protection		200 mVpp
External trigger sensitivity (minimum required signal swing)		
External trigger level	software programmable	$\pm 5$ V in steps of 1 mV
External trigger bandwidth	50 $\Omega$ 5 k $\Omega$	DC to 400 MHz DC to 300 MHz
Minimum external trigger pulse width		$\geq 2$ samples
		<b>X1, X2, X3</b>
		3.3V LVTTTL logic inputs
		For electrical specifications refer to „Multi Purpose I/O lines“ section.

### Multi Purpose I/O lines

Number of multi purpose output lines		one, named X0
Number of multi purpose input/output lines		three, named X1, X2, X3
Multi Purpose line		<b>X0</b>
Input: available signal types	software programmable	n.a.
Input: signal levels		n.a.
Input: impedance		n.a.
Input: maximum voltage level		n.a.
Input: maximum bandwidth		n.a.
Output: available signal types	software programmable	Run-, Arm-, Trigger-Output, Marker-Output, Synchronous Digital-Out, Asynchronous Digital-Out ADC Clock Output,
Output: impedance		50 $\Omega$
Output: drive strength		Capable of driving 50 $\Omega$ loads, maximum drive strength $\pm 48$ mA
Output: type / signal levels		3.3V LVTTTL, TTL compatible for high impedance loads
Output: update rate (synchronous modes)		sampling clock
		<b>X1, X2, X3</b>
		Asynchronous Digital-In, Logic trigger
		3.3 V LVTTTL
		10 k $\Omega$ to 3.3 V
		-0.5 V to +4.0 V
		125 MHz
		Run-, Arm-, Trigger-Output, Marker-Output, Synchronous Digital-Out, Asynchronous Digital-Out,

## Sequence Replay Mode

Number of sequence steps	software programmable	1 up to 4096 (sequence steps can be overloaded at runtime)
Number of memory segments	software programmable	2 up to 64k (segment data can be overloaded at runtime)
Minimum segment size	software programmable	32 samples in steps of 8 samples.
Maximum segment size	software programmable	512 MS / active channels / number of sequence segments (round up to the next power of two)
Loop Count	software programmable	1 to (1M - 1) loops
Sequence Step Commands	software programmable	Loop for #Loops, Next, Loop until Trigger, End Sequence
Special Commands	software programmable	Data Overload at runtime, sequence steps overload at runtime, readout current replayed sequence step
Limitations for synchronized products		Software commands changing the sequence as well as „Loop until trigger“ are not synchronized between cards. This also applies to multiple AWG modules in a generatorNETBOX.

## Clock

Clock Modes	software programmable	internal PLL, external clock, external reference clock, sync
Internal clock range (PLL mode)	software programmable	see „Clock Limitations“ table below
Internal clock accuracy		≤ ±1.0 ppm (at time of calibration in production)
Internal clock aging		≤ ±0.5 ppm / year
PLL clock setup granularity (int. or ext. reference)		1 Hz
External reference clock range	software programmable	128 kHz up to 125 MHz
Direct external clock to internal clock delay		4.3 ns
Direct external clock range		see „Clock Limitations and Bandwidth“ table below
External clock type		Single level comparator
External clock input level		±5 V (5 kΩ), ±2.5 V (50 Ω),
External clock input impedance	software programmable	50 Ω / 5 kΩ
External clock over voltage protection		±20 V (5 kΩ), 5 Vrms (50 Ω)
External clock sensitivity (minimum required signal swing)		200 mVpp
External clock level	software programmable	±5 V in steps of 1 mV
External clock edge		rising edge used
External reference clock input duty cycle		45% - 55%
Clock output electrical specification		Available via Multi Purpose output X0. Refer to „Multi Purpose I/O lines“ section.
Synchronization clock multiplier „N“ for different clocks on synchronized cards	software programmable	N being a multiplier (1, 2, 3, 4, 5, ... Max) of the card with the currently slowest sampling clock. The card maximum (see „Clock Limitations and Bandwidth“ table below) must not be exceeded.
Channel to channel skew on one card		< 200 ps (typical)
Skew between star-hub synchronized cards		TBD

## Connectors

Analog	SMB male (one for each single-ended input/output)	Cable-Type: Cab-3f-xx-xx
Trigger Input	SMB male	Cable-Type: Cab-3f-xx-xx
Clock Input	SMB male	Cable-Type: Cab-3f-xx-xx
Multi Purpose I/O	MMCX female (4 lines)	Cable-Type: Cab-1m-xx-xx

## Environmental and Physical Details

Dimension (Single Card M2p.65x3 or 65x8)	8 channel AWG	168 mm (½ PCIe length) x 107 mm x 30 mm (double slot width)
Dimension (all other single cards)		168 mm (½ PCIe length) x 107 mm x 20 mm (single slot width)
Dimension (Card with -SH6tm or -SH16tm installed)		168 mm (½ PCIe length) x 107 mm x 40 mm (double slot width)
Dimension (Card with -SH6ex or -SH16ex installed)		245 mm (¾ PCIe length) x 107 mm x 20 mm (single slot width)
Weight (M2p.59xx series)	maximum	215 g
Weight (M2p.65x0, M2p.65x1, M2p.65x6 series)	maximum	195 g
Weight (M2p.65x3, M2p.65x8 series)	maximum	TBD
Weight (Star-Hub Option -SH6ex, -SH6tm)	including 6 sync cables	65 g
Weight (Star-Hub Option -SH16ex, -SH16tm)	including 16 sync cables	90 g
Warm up time		10 minutes
Operating temperature		0 °C to 40 °C
Storage temperature		-10 °C to 70 °C
Humidity		10% to 90%

## PCI Express specific details

PCIe slot type	x4, Generation 1
PCIe slot compatibility (physical)	x4, x8, x16
PCIe slot compatibility (electrical)	x1, x4, x8, x16, Generation 1, Generation 2, Generation 3
Sustained streaming mode (Card-to-System: M2p.59xx)	> 700 MB/s (measured with a chipset supporting a TLP size of 256 bytes, using PCIe x4 Gen1)
Sustained streaming mode (System-to-Card: M2p.65xx)	> 700 MB/s (measured with a chipset supporting a TLP size of 256 bytes, using PCIe x4 Gen1)

## Certification, Compliance, Warranty

EMC Immunity	Compliant with CE Mark
EMC Emission	Compliant with CE Mark
Product warranty	5 years starting with the day of delivery
Software and firmware updates	Life-time, free of charge

## Power Consumption

		<b>3.3V</b>	<b>12 V</b>	<b>Total</b>
M2p.6530-x4	Typical values: All channels activated, Sample rate: 40 MSps Output signal: 10 MHz sine wave, Output level: +/- 3.0 V into 50 $\Omega$ load	0.1 A	TBD A	TBD W
M2p.6531-x4		0.1 A	TBD A	TBD W
M2p.6536-x4		0.1 A	TBD A	TBD W
M2p.6533-x4		0.1 A	TBD A	TBD W
M2p.6560-x4	Typical values: All channels activated, Sample rate: 125 MSps Output signal: 10 MHz sine wave, Output level: +/- 3.0 V into 50 $\Omega$ load	0.1 A	TBD A	TBD W
M2p.6561-x4		0.1 A	TBD A	TBD W
M2p.6566-x4		0.1 A	TBD A	TBD W
M2p.6568-x4		0.1 A	TBD A	TBD W

## MTBF

MTBF

TBD hours

## Clock Limitations

	M2p.653x	M2p.656x
max internal clock (non-synchronized cards)	40 MS/s	125 MS/s
min internal clock (non-synchronized cards)	1 kS/s	1 kS/s
max internal clock (cards synchronized via star-hub)	40 MS/s	125 MS/s
min internal clock (cards synchronized via star-hub)	128 kS/s	128 kS/s
max direct external clock	40 MS/s	125 MS/s
min direct external clock	DC	DC

## Bandwidth and Filters

	Filter	-3dB bandwidth	Filter characteristic
Analog bandwidth does not include Sinc response of DAC	Filter 0	70 MHz	third-order Butterworth
	Filter 1	20 MHz	fifth-order Butterworth
	Filter 2	5 MHz	fourth-order Bessel
	Filter 3	1 MHz	fourth-order Bessel

## Dynamic Parameters

	M2p.653x			
	40 MS/s		40 MS/s	
Test - Samplerate	800 kHz		4 MHz	
Output Frequency	±900mV   ±3000mV		±900mV   ±3000mV	
Output Level in 50 Ω	1 MHz		5 MHz	
Used Filter	1 MHz		5 MHz	
NSD (typ)	-TBD dBm/Hz	-TBD dBm/Hz	-TBD dBm/Hz	-TBD dBm/Hz
SNR (typ)	TBD dB	TBD dB	TBD dB	TBD dB
THD (typ)	-TBD dB	-TBD dB	-TBD dB	-TBD dB
SINAD (typ)	TBD dB	TBD dB	TBD dB	TBD dB
SFDR (typ), excl harm.	TBD dB	TBD dB	TBD dB	TBD dB
ENOB (SINAD)	TBD	TBD	TBD	TBD
ENOB (SNR)	TBD	TBD	TBD	TBD

	M2p.656x					
	125 MS/s		125 MS/s		125 MS/s	
Test - Samplerate	800 kHz		4 MHz		16 MHz	
Output Frequency	±900mV   ±3000mV		±900mV   ±3000mV		±900mV   ±3000mV	
Output Level in 50 Ω	1 MHz		5 MHz		20 MHz	
Used Filter	1 MHz		5 MHz		20 MHz	
NSD (typ)	-142 dBm/Hz	-132 dBm/Hz	-142 dBm/Hz	-132 dBm/Hz	-142 dBm/Hz	-132 dBm/Hz
SNR (typ)	90.7 dB	91.1 dB	83.7 dB	84.1 dB	77.7 dB	78.1 dB
THD (typ)	-74.0 dB	-74.0 dB	-70.5 dB	-70.5 dB	-66.0 dB	-61.9 dB
SINAD (typ)	73.9 dB	73.9 dB	69.8 dB	69.8 dB	65.7 dB	60.9 dB
SFDR (typ), excl harm.	97.0 dB	95.0 dB	88.0 dB	88.0 dB	90.0 dB	89.0 dB
ENOB (SINAD)	12.0	12.0	11.3	11.3	10.6	9.8
ENOB (SNR)	14.7	14.8	13.5D	13.6	12.5	12.6

THD and SFDR are measured at the given output level and 50 Ohm termination with a high resolution M3i.4860/M4i.4450-x8 data acquisition card and are calculated from the spectrum. Noise Spectral Density is measured with built-in calculation from an HP E4401B Spectrum Analyzer. All available D/A channels are activated for the tests. SNR and SFDR figures may differ depending on the quality of the used PC. NSD = Noise Spectral Density, THD = Total Harmonic Distortion, SFDR = Spurious Free Dynamic Range.

## SFDR and THD versus signal frequency

TBD

TBD

Measurements done with a spectrum analyzer bandwidth of TBD MHz.

Please note that the output bandwidth limit also affects the THD as harmonics higher than the bandwidth are filtered.

# Hardware block diagram

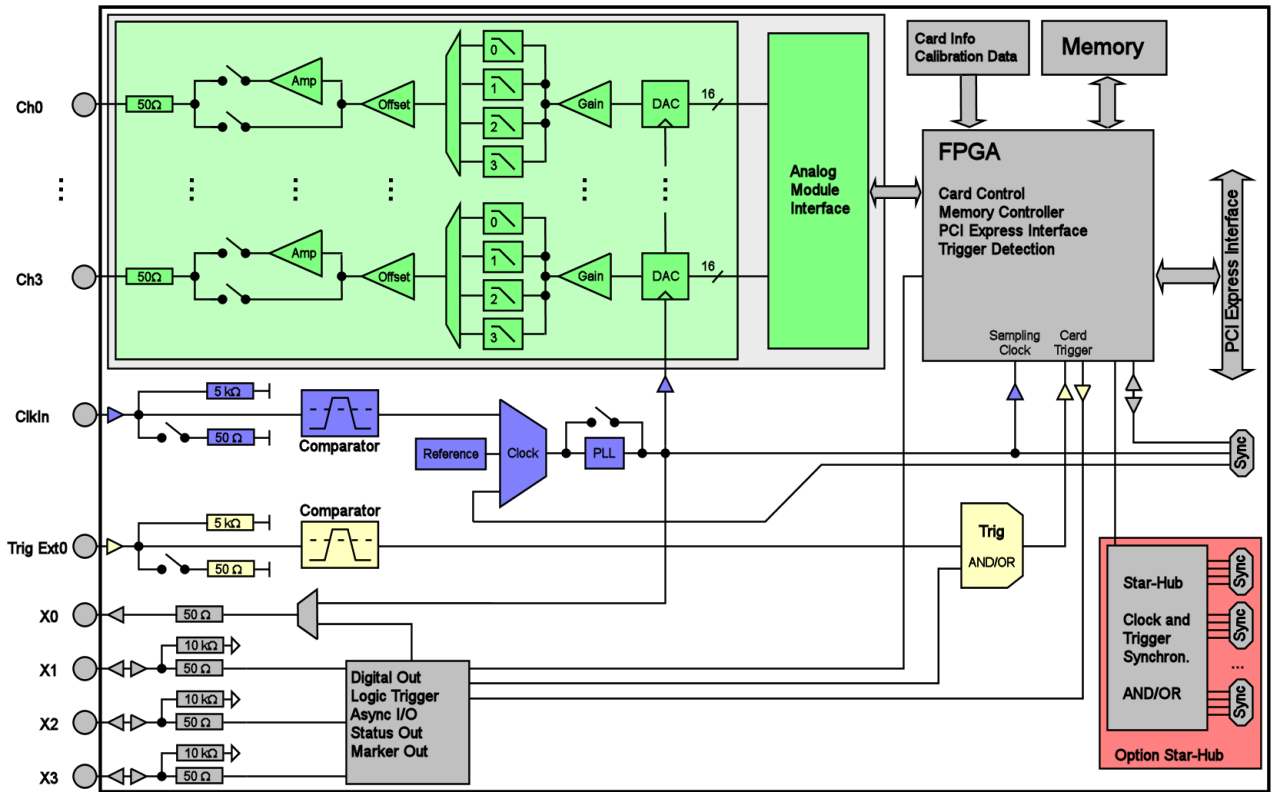



## Order Information

The card is delivered with 512 MSample on-board memory and supports standard replay, FIFO replay (streaming), Multiple Replay, Gated Replay, Continuous Replay (Loop), Single-Restart as well as Sequence. Operating system drivers for Windows/Linux 32 bit and 64 bit, examples for C/C++, LabVIEW (Windows), MATLAB (Windows and Linux), LabWindows/CVI, IVI, .NET, Delphi, Java, Python and a Base license of the measurement software SBench 6 are included.

**Adapter cables are not included. Please order separately!**

### PCI Express x4

Order no.	D/A Resolution	Standard mem	Single-Ended Outputs	
M2p.6530-x4	16 Bit	512 MSample	1 channel	40 MS/s
M2p.6531-x4	16 Bit	512 MSample	2 channels	40 MS/s
M2p.6536-x4	16 Bit	512 MSample	4 channels	40 MS/s
M2p.6533-x4	16 Bit	512 MSample	8 channels	40 MS/s
M2p.6560-x4	16 Bit	512 MSample	1 channel	125 MS/s
M2p.6561-x4	16 Bit	512 MSample	2 channels	125 MS/s
M2p.6566-x4	16 Bit	512 MSample	4 channels	125 MS/s
M2p.6568-x4	16 Bit	512 MSample	4 channels	125 MS/s
			8 channels	80 MS/s

### Options

Order no.	Option
M2p.xxxx-SH6ex <sup>(1)</sup>	Synchronization Star-Hub for up to 6 cards incl. cables, only one slot width, card length 245 mm
M2p.xxxx-SH6tm <sup>(1)</sup>	Synchronization Star-Hub for up to 6 cards incl. cables, two slots width, standard card length
M2p.xxxx-SH16ex <sup>(1)</sup>	Synchronization Star-Hub for up to 16 cards incl. cables, only one slot width, card length 245 mm
M2p.xxxx-SH16tm <sup>(1)</sup>	Synchronization Star-Hub for up to 16 cards incl. cables, two slots width, standard card length
M2p-upgrade	Upgrade for M2p.xxxx: Later installation of option Star-Hub

### Services

Order no.	
Recal	Recalibration at Spectrum incl. calibration protocol

### Cables

for Connections	Length	Order no.				
		to BNC male	to BNC female	to SMA male	to SMA female	to SMB female
Analogue/Clock-In/Trig-In	80 cm	Cab-3f-9m-80	Cab-3f-9f-80	Cab-3f-3mA-80	Cab-3f-3fA-80	Cab-3f-3f-80
Analogue/Clock-In/Trig-In	200 cm	Cab-3f-9m-200	Cab-3f-9f-200	Cab-3f-3mA-200	Cab-3f-3fA-200	Cab-3f-3f-200
Probes (short)	5 cm		Cab-3f-9f-5			
Clk-Out/Trig-Out/Extra	80 cm	Cab-1m-9m-80	Cab-1m-9f-80	Cab-1m-3mA-80	Cab-1m-3fA-80	Cab-1m-3f-80
Clk-Out/Trig-Out/Extra	200 cm	Cab-1m-9m-200	Cab-1m-9f-200	Cab-1m-3mA-200	Cab-1m-3fA-200	Cab-1m-3f-200
Information	The standard adapter cables are based on RG174 cables and have a nominal attenuation of 0.3 dB/m at 100 MHz.					

### Software SBench6

Order no.	
SBench6	Base version included in delivery. Supports standard mode for one card.
SBench6-Pro	Professional version for one card: FIFO mode, export/import, calculation functions
SBench6-Multi	Option multiple cards: Needs SBench6-Pro. Handles multiple synchronized cards in one system.
Volume Licenses	Please ask Spectrum for details.

### Software Options

Order no.	
SPc-RServer	Remote Server Software Package - LAN remote access for M2i/M3i/M4i/M4x/M2p cards
SPc-SCAPP	Spectrum's CUDA Access for Parallel Processing - SDK for direct data transfer between Spectrum card and CUDA GPU. Includes RDMA activation and examples. Signed NDA needed for access.

<sup>(1)</sup> : Just one of the options can be installed on a card at a time.

<sup>(2)</sup> : Third party product with warranty differing from our export conditions. No volume rebate possible.

#### Technical changes and printing errors possible

SBench, digitizerNETBOX and generatorNETBOX are registered trademarks of Spectrum Instrumentation GmbH. Microsoft, Visual C++, Windows, Windows 98, Windows NT, Window 2000, Windows XP, Windows Vista, Windows 7, Windows 8 and Windows 10 are trademarks/registered trademarks of Microsoft Corporation. LabVIEW, DASyLab, Diadem and LabWindows/CVI are trademarks/registered trademarks of National Instruments Corporation. MATLAB is a trademark/registered trademark of The Mathworks, Inc. Delphi and C++Builder are trademarks/registered trademarks of Embarcadero Technologies, Inc. Keysight VEE, VEE Pro and VEE OneLab are trademarks/registered trademarks of Keysight Technologies, Inc. FlexPro is a registered trademark of Weisang GmbH & Co. KG. PCIe, PCI Express and PCI-X and PCI-SIG are trademarks of PCI-SIG. LXI is a registered trademark of the LXI Consortium. PICMG and CompactPCI are trademarks of the PCI Industrial Computer Manufacturers Group. Oracle and Java are registered trademarks of Oracle and/or its affiliates. Intel and Intel Core i3, Core i5, Core i7, Core i9 and Xeon are trademarks and/or registered trademarks of Intel Corporation. AMD, Opteron, Sempron, Phenom, FX, Ryzen and EPYC are trademarks and/or registered trademarks of Advanced Micro Devices. NVIDIA, CUDA, GeForce, Quadro and Tesla are trademarks/registered trademarks of NVIDIA Corporation.